

KAWASAKI Z1000 '16- / Z1100 '26-

M O U N T I N G I N S T R U C T I O N S







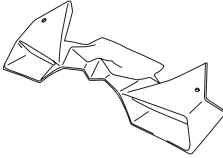

VIDEO

REF:22782

NAKED FRONTAL SPOILERS



ALLEN
Nº 3
Nº 4
Nº 5
Nº 6

ID	PIEZA/PART	DESCRIPCIÓN	DESCRIPTION	QTY	REF
1		Alerón frontal Naked	Naked frontal spoiler	1	22782J/N/CM3
2		Soporte Izquierdo (L)	Left support (L)	1	SOPOR2P2-L22782
3		Soporte derecho (R)	Right support (R)	1	SOPOR2P2-R22782
4		Casquillo Ø14x Ø8,5x 10mm	Ø14x Ø8,5x 10mm Arrowhead	2	CASQUI-----576
5		Tornillo Allen M8x50 ISO7380	M8x50 ISO7380 Allen screw	2	TORNI-I7380-577
6		Cinta adhesiva de doble cara (30x10mm)	double-sided adhesive tape(30x10mm)	4	ADHESI-----263
7		Tornillo Allen M5x16 DIN7991	M5x16 DIN7991 Allen screw	2	TORNI-D7991-867
8		Arandela de goma Ø4,5 x Ø14 x 4mm	Ø4,5 x Ø14 x 4mm Rubber washer	2	ARAND-GD13D5X4-
9		Tapón tornillo M5 DIN7991	M5 DIN7991 screw cap	2	TAPON-----92

KAWASAKI Z1000 '16- / Z1100 '26-

INSTRUCCIONES DE MONTAJE - MOUNTING INSTRUCTIONS - MONTAGEANLEITUNG

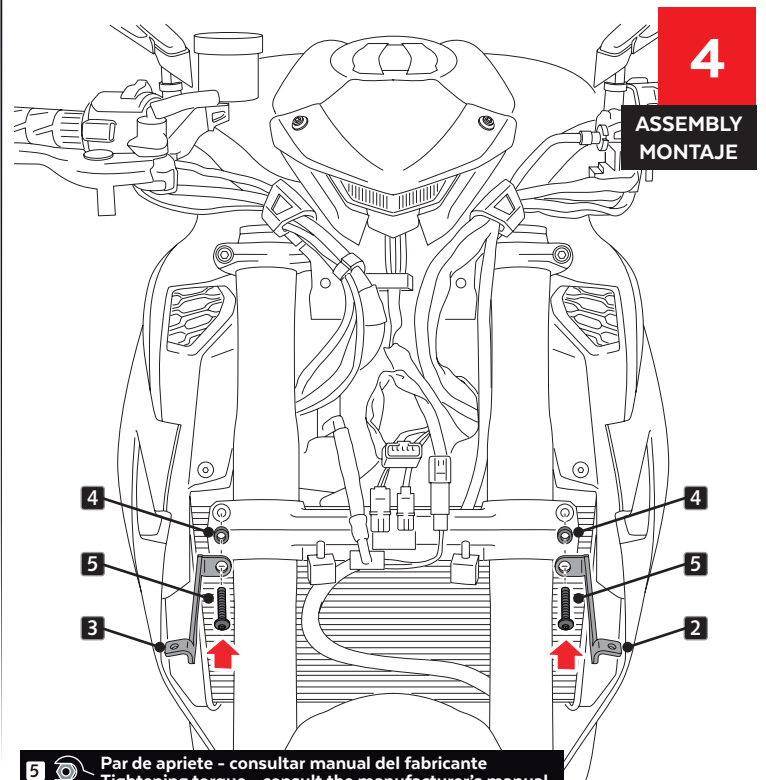
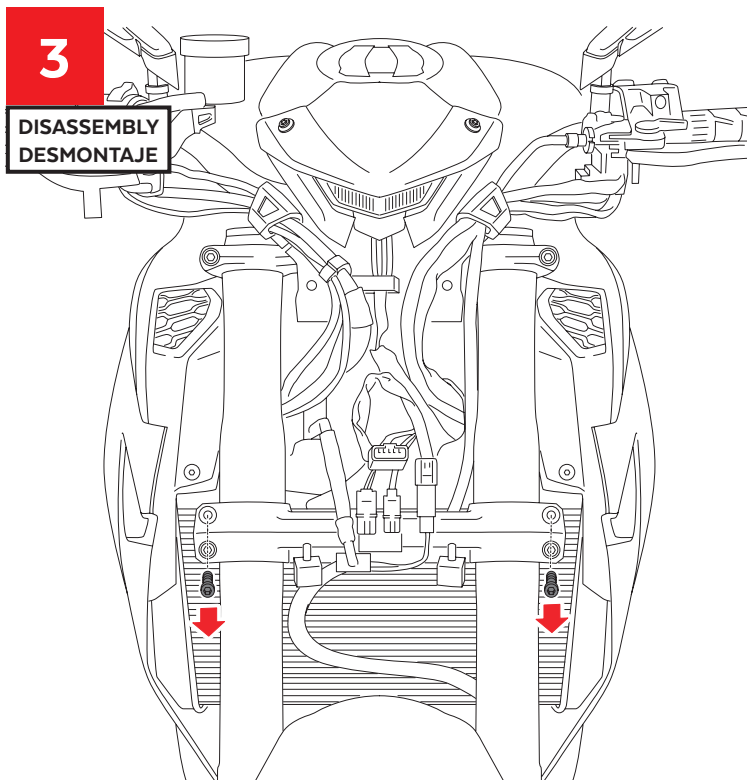
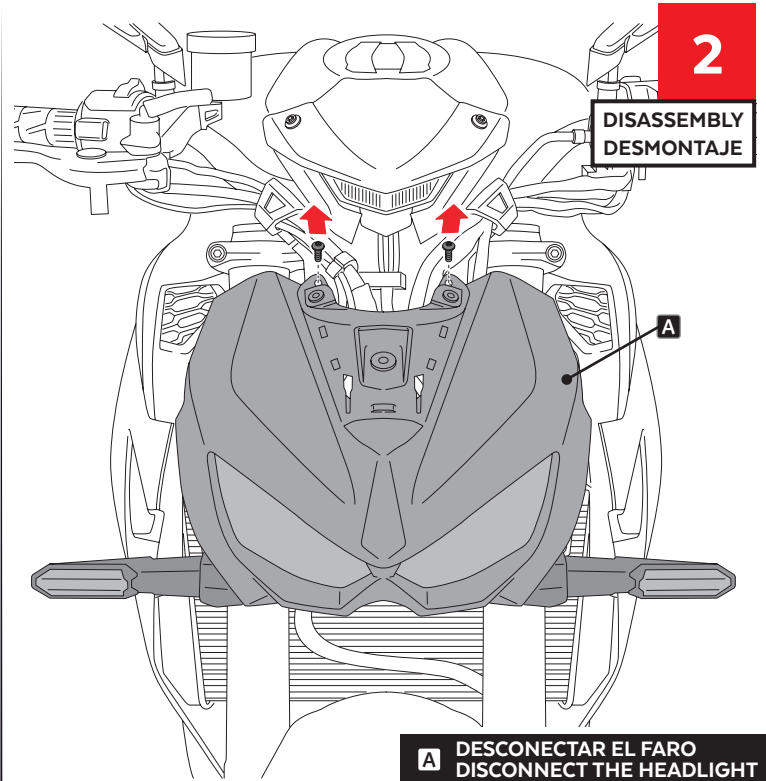
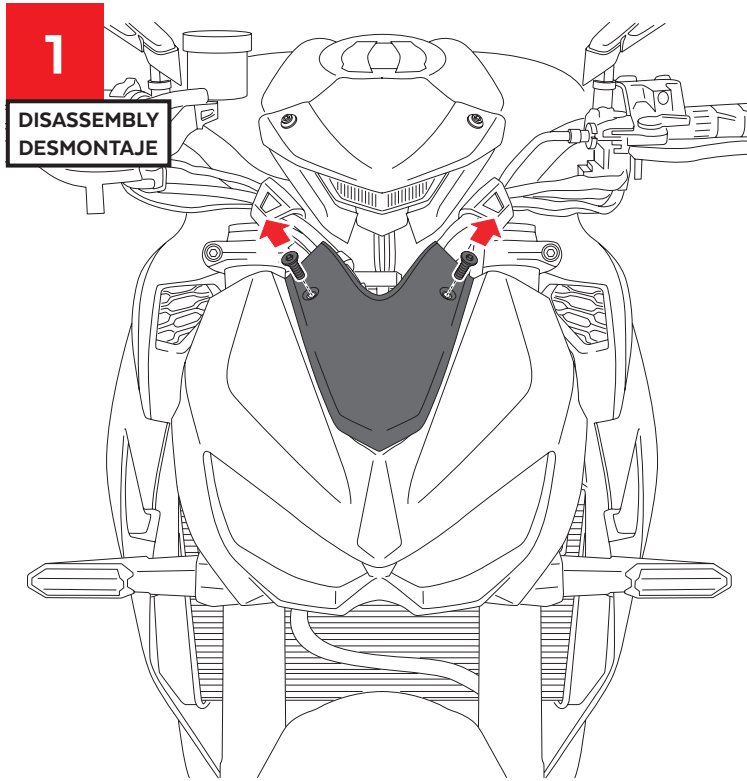

KAWASAKI Z1000 '16- / Z1100 '26-

INSTRUCCIONES DE MONTAJE - MOUNTING INSTRUCTIONS - MONTAGEANLEITUNG

5

ASSEMBLY
MONTAJE

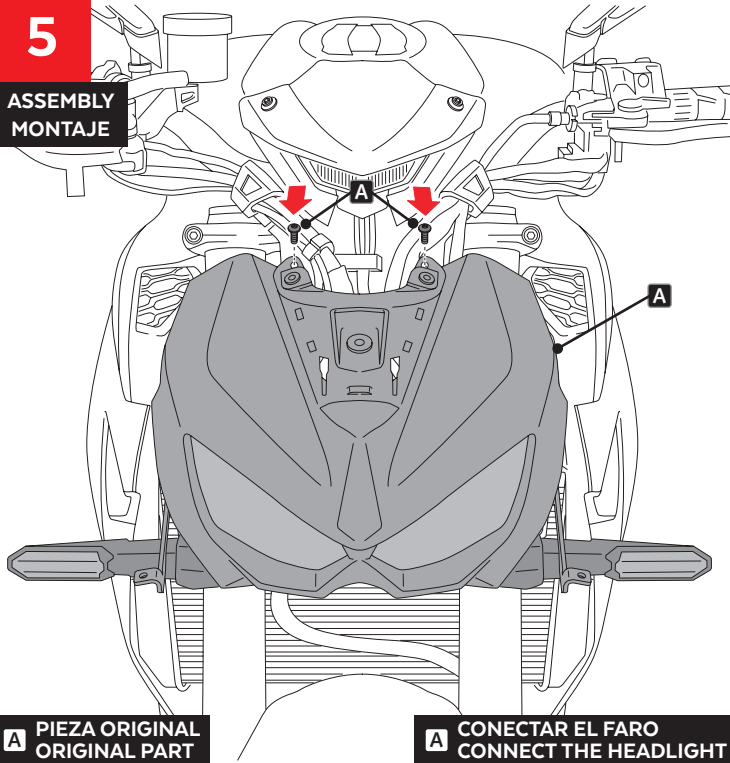

A PIEZA ORIGINAL
ORIGINAL PART

A CONECTAR EL FARO
CONNECT THE HEADLIGHT

6

ASSEMBLY
MONTAJE

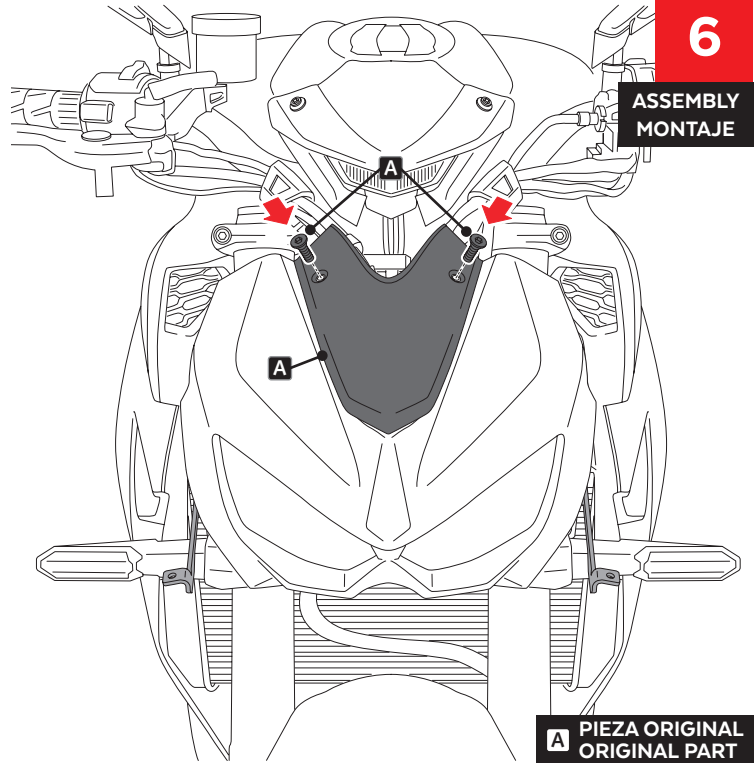

A PIEZA ORIGINAL
ORIGINAL PART

7

ASSEMBLY
MONTAJE

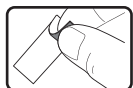
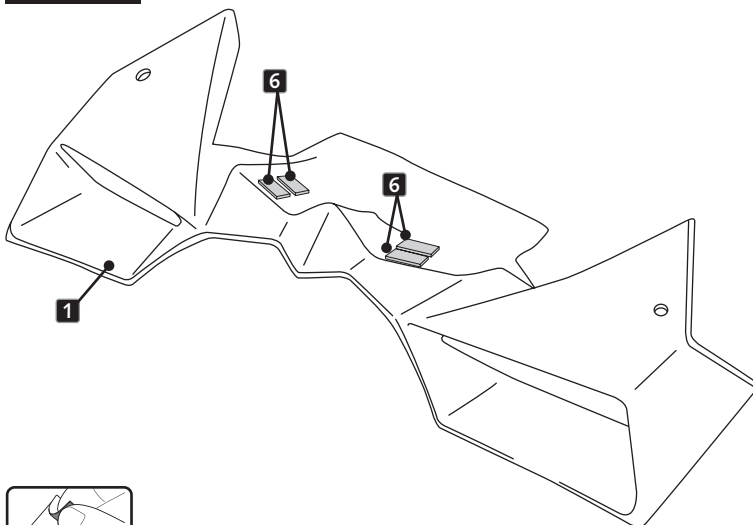

6 EXTRAER EL PAPEL DE LA CINTA ADHESIVA DE DOBLE CARA.
EXTRACT THE PAPER FROM THE DOUBLE-SIDE ADHESIVE TAPE.

8

ASSEMBLY
MONTAJE

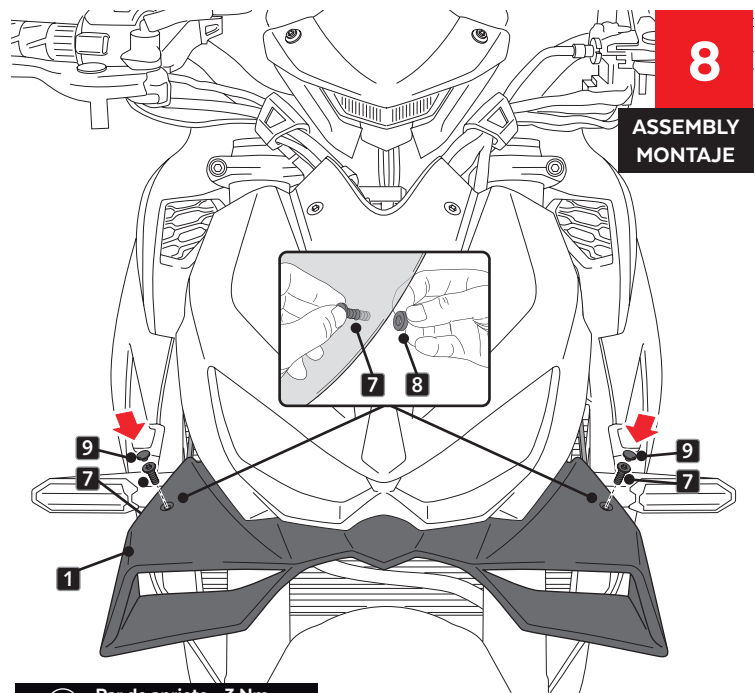

7 Par de apriete - 3 Nm
Tightening torque - 3Nm

APPLY PRESSURE ON ADHESIVE ARE FOR 1 MINUT. IDEAL TAPE APPLI-
CATION IS ACCOMPLISHED WHEN TEMPERATURE IS BETWEEN 21°C AND
38°C AND THE BOND IS ALLOWED TO DWELL 24 HOURS.